

## Overview

Vision EV Series Batteries provide superior performance, capacities and reliability. Using state of art dry cell technology the EV series is designed for environmentally sensitive areas that require enhanced cycle life capabilities in commercial, industrial, residential, and private applications. The maintenance-free (VRLA) construction and advanced design features makes the EV Series the definitive choice for a wide variety of markets; Solar and Renewable Energy Storage; Electric Vehicle and Golf cart; Industrial equipment, Floor Machines, Forklifts, Aerial lifts, and Robotics; Marine, RV, and no-idle solutions; Mobility and Medical Equipment; Telecom, Broadband and Cable TV; UPS systems.

## Features and Benefits

- High density lead paste and specialized paste formula for deep cycle application.
- High strength ABS or PP case & cover and valve-regulated construction.
- Maintenance-free.
- High capacities.
- Environmentally friendly, Classified as “ Non-Spillable Battery” for transportation.
- High tin alloy grids offer: Less gassing, High corrosion-resistant, Low self discharge, Alloy sheeting material for deep cycle applications.
- Exceptional adaptability to operate at high and low temperature environments.
- Durable copper and stainless steel terminals for high electric conductivity.
- Excellent cycle life: 80% DOD 800 cycles.
- Exclusive electrolyte formula and separator, For protecting the electrolyte density from stratification.
- Superior design allows for fast charge acceptance and resistance to over-discharge.

## Battery of dimensions

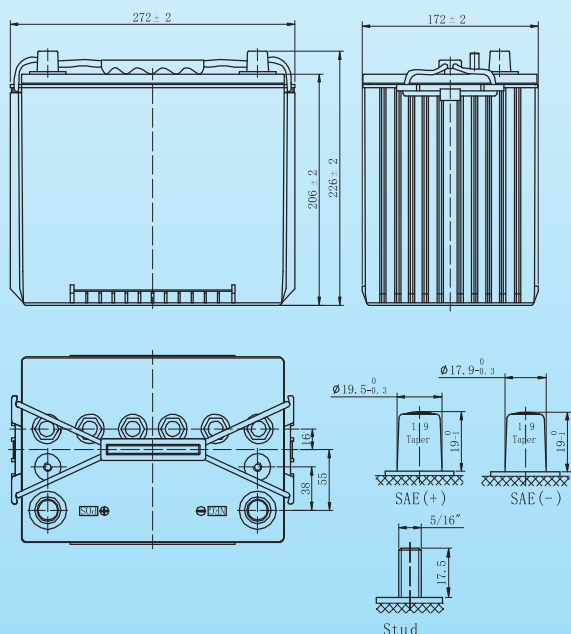

## Battery Specification

Performance Characteristics	
Nominal Voltage	12V
Number of cell	6
Industry Type No.	24
Terminal	AM
Container material	PP
<b>Amp Hours(AH)@ 77°F(25°C)</b>	
20 hour rate F.V.(1.75V/Cell)	85Ah
10 hour rate F.V.(1.75V/Cell)	80Ah
5 hour rate F.V.(1.75V/Cell)	72Ah
3 hour rate F.V.(1.75V/Cell)	68Ah
2 hour rate F.V.(1.75V/Cell)	60Ah
1 hour rate F.V.(1.75V/Cell)	50Ah
<b>Minutes of Discharge@(80°F/27°C)</b>	
25A F.V.(1.75V/Cell)	165min
75A F.V.(1.75V/Cell)	41min
<b>Internal Resistance</b>	
Fully Charged battery 77°F(25°C)	≤3.5 mOhms
<b>Self-Discharge</b>	
3% of capacity declined per month at 20°C(average)	
<b>Cranking Amps</b>	
32°F/0°C	545
0°F/-18°C	423
<b>Max. Discharge Current 77°F(25°C)</b>	680A(5s)
<b>Charge Methods: Constant Voltage Charge 77°F(25°C)</b>	
Cycle use	2.40-2.45VPC
Initial Charging Current	25.5A
Float use	2.20-2.30VPC

## Dimensions and Weight

Length(mm / inch)	272 / 10.7
Width(mm / inch)	172 / 6.8
Height(mm / inch)	206 / 8.1
Total Height(mm / inch)	226 / 8.9
Approx. Weight(Kg / lbs)	25.1 / 55.3

\* Weight deviation: ± 3%

(Note)The above characteristics data are average values obtained within three charge/discharge cycles not the minimum values. All data shall be changed without notice, Vision reserves the right to explain and update the information contained hereinto.

