

Technology - Art - Sound
Manufactured by
electromedia

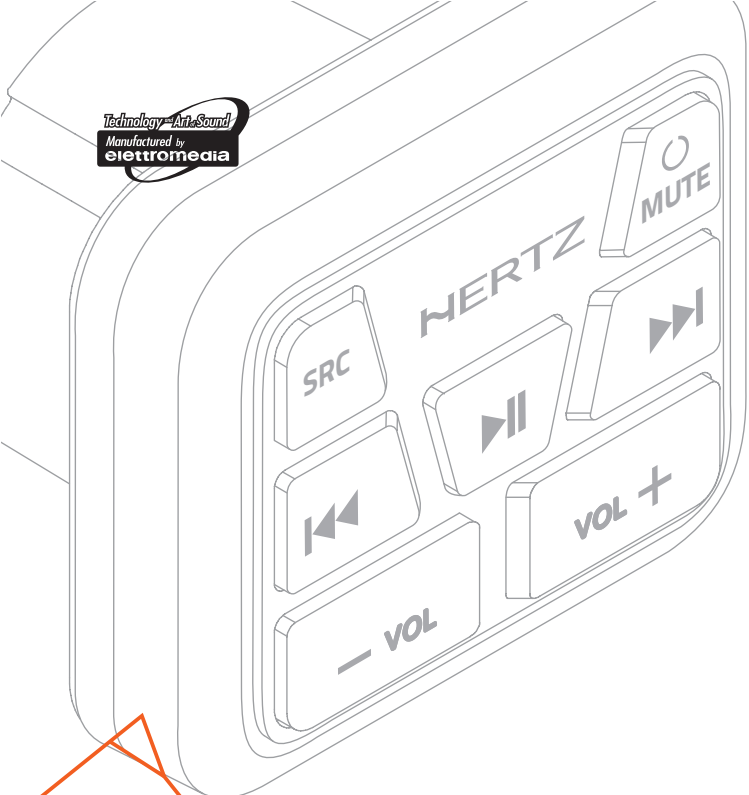

POWER
FOR
THE **WAVES**
PURE MARINE
CERTIFIED PRODUCT



marine
HMC U1
REMOTE CONTROL
FOR HMR SERIES

hertzaudiovideo.com

QUICK
START
GUIDE

INSTALLATION

BEFORE STARTING

1. This device is exclusively for use in vessels with a negative ground 12 V power supply.
2. Read these instructions carefully.
3. Make sure the battery “-” terminal is disconnected before starting.
This is to prevent short circuits during installation. (Figure 1)

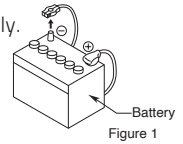
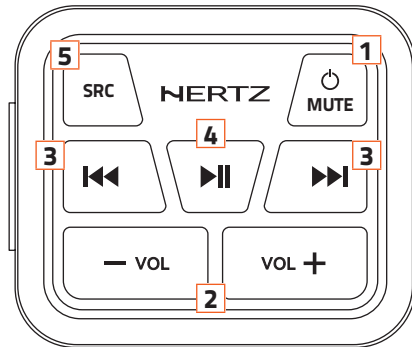





Figure 1

INSTALLATION CAUTIONS

1. In order to avoid any interference, do not install the tuner module or control unit in the proximity of the engine compartment.
2. The use of unauthorized parts can cause permanent damage to the unit.
3. Always check your wire connections to ensure proper installation before turning the unit on.
4. Consult with your nearest dealer for proper installation or if other accessories are needed to complete the installation.
5. Seek assistance if modifications or drilling holes to your vessel is needed.
6. Do not install the unit where it will be subjected to excessive moisture, dust, dirt, foreign particles or vibration. Areas of high temperature from the engine, direct sunlight, or heat sources should also be avoided.
7. Do not install the unit in a location where it will interfere with the vessel operation, or it will injure the passengers if there is a sudden or emergency stop.

CONTROLS



- 1**  Button
 - Mute ON / OFF (short press)
 - Power On (short press)
 - Power OFF (long press)
- 2** VOL +/- Button
 - Adjust volume level
- 3**   Button
 - AM/FM/WB/DAB mode: previous/next preset (short press).
 - AM/FM mode: SEEK the next/previous strongest station (long press).
 - USB/BT mode: previous/next track (short press).
 - USB/BT mode: fast forward / rewind (press and hold).
- 4**  Button
 - USB/BT mode: PLAY or PAUSE playback (short press).
- 5** SRC Button
 - Short press “SRC” to move to the next option.

MOUNTING

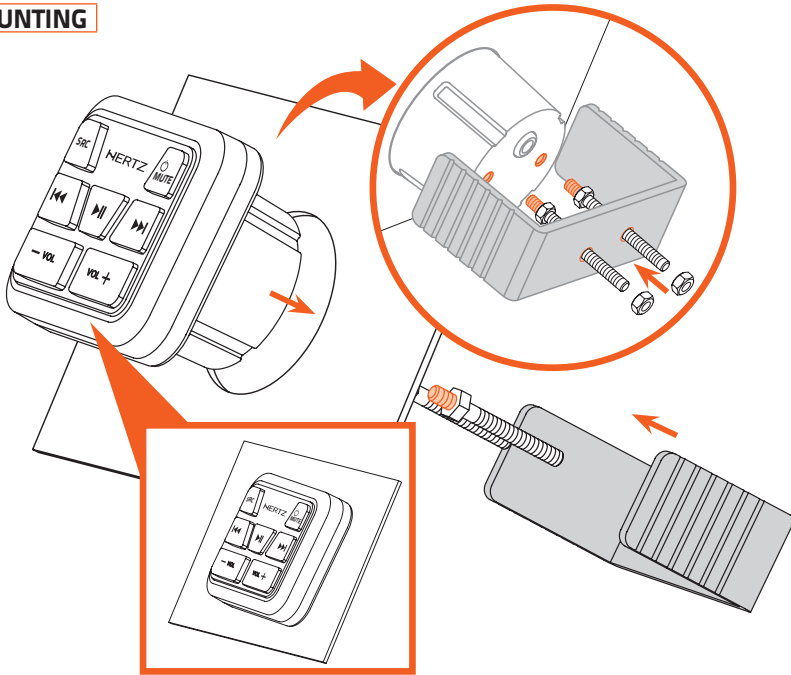

CONNECTION

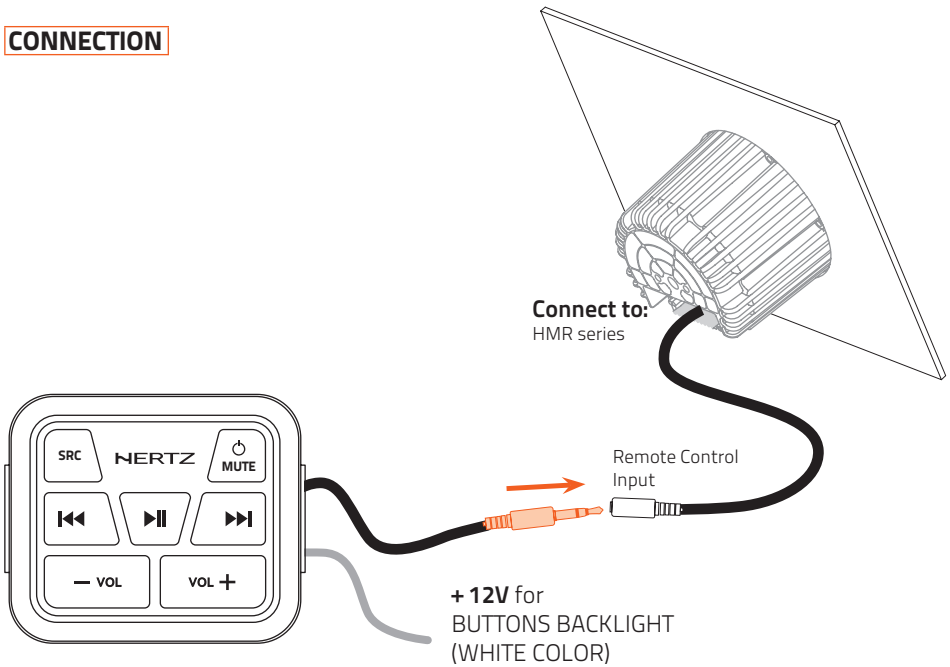

DIMENSIONS

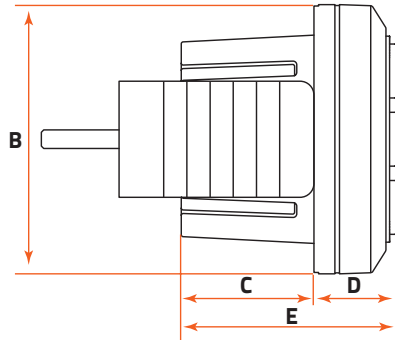
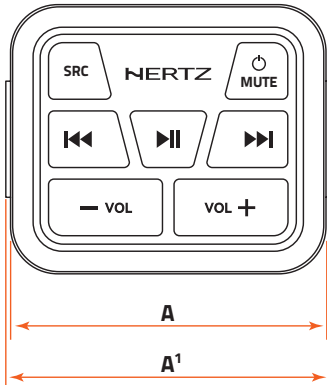

	A	A ¹	B	C	D	E	
HMC U1	68	70	58	29	18	46	mm
	2.68	2.76	2.28	1.13	0.70	1.83	in.

SIZE & MOUNTING

Mounting Hole diameter mm (in.)	Ø 45 (1,77)
Mounting Method	U-Bracket

HERTZ

PART OF **ELETTROMEDIA**

Strada Regina Km 3,500 - Marignano

62018 Potenza Picena (MC) Italy

T +39 0733 870 870 - F +39 0733 870 880

www.elettromedia.it